

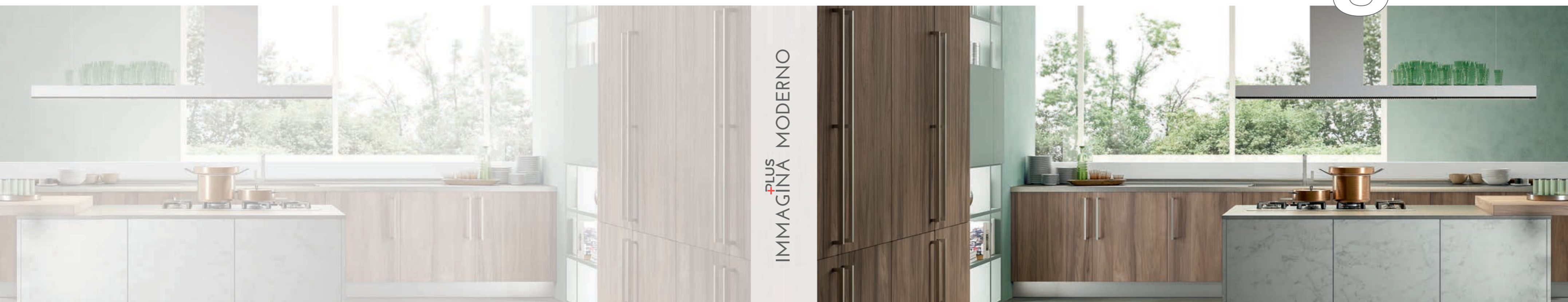

immagina ⁺PLUS



IMMAGINA ⁺PLUS MODERNO



LUBE INDUSTRIES SRL
Via dell'Industria, 4 - 62010 Treia (MC) Italia
Tel. centralino 0733 8401 (r.a.)
Fax 0733 840222 - 0733 840333
info@cucinelube.it - www.cucinelube.it

Lube Industries srl è dotata di Sistemi di Gestione per la Qualità, la Salute e Sicurezza, in conformità alle norme UNI EN ISO 9001 e BS OHSAS 18001. Per maggiori informazioni visita il nostro sito www.cucinelube.it





immagina⁺PLUS

IMMAGINA PLUS È UNA COLLEZIONE RICCA DI NOVITÀ. NUOVE FINITURE E COLORI AL PASSO CON I TREND STILISTICI DI OGGI, NUOVI ACCESSORI E COMPONENTI TECNOLOGICI, PER PROGETTARE UNA CUCINA CHE SI ADATTA PERFETTAMENTE AD OGNI ESIGENZA.

IMMAGINA PLUS IS A COLLECTION RICH IN NEW FEATURES. NEW FINISHES AND COLOURS IN STEP WITH THE LATEST TRENDS, NEW ACCESSORIES AND TECHNOLOGY COMPONENTS COMBINE TO DESIGN A KITCHEN WHICH PERFECTLY SUITS ALL NEEDS.

pag.4

.BRIDGE

ANTA CON MANIGLIA
FRONTALE E AD INCASSO
DOOR WITH FRONT-MOUNTED
AND RECESSED HANDLE

pag.66

.HEAD

ANTA CON MANIGLIA
APPLICATA IN TESTA
DOOR WITH
TOP-MOUNTED HANDLE

pag.100

.NECK

ANTA SENZA PROFILO PER
APERTURA CON GOLA
DOOR WITHOUT PROFILE
FOR FINGER RAIL OPENING

pag.150

.LUX

ANTE CON TRE PROFILI PER
APERTURA CON GOLA
DOOR WITH THREE PROFILES
FOR FINGER RAIL OPENINGS



APERTURA LUX⁺

ANTE CON TRE PROFILI
PER APERTURA CON GOLA
DOOR WITH THREE PROFILES
FOR FINGER RAIL OPENINGS

TRE TIPI DIVERSI DI PROFILI PER ANTE CON APERTURA
CON GOLA, CHE GARANTISCONO LA MASSIMA
PERSONALIZZAZIONE ED UNA SEMPRE PIÙ AMPIA POSSIBILITÀ
DI ABBINAMENTO AI MATERIALI E FINITURE DELLA
COLLEZIONE.

*THREE DIFFERENT CABINET FRONT PROFILES WITH FINGER RAIL, WHICH
ASSURE THE MAXIMUM CUSTOMISATION AND AN EVER-WIDENING VARIETY
OF COMBINATIONS WITH THE COLLECTION MATERIALS AND FINISHES.*

15⁺ LUX

MELAMINICO PELTRO |
MELAMINICO LARICE LAGUNA |
MELAMINICO VERDE MARINO |
WORK TOP: UNICOLOR GRIGIO MONSONE

*PEWTER MELAMINE |
LAGOON LARCH MELAMINE |
SEA GREEN MELAMINE
WORK TOP: MONSOON GREY UNICOLOR*









LXXXI

immagina plus



BASI SOSPESE

LE BASI CON IL PIANO COTTURA SEMBRANO SOSPESE, GRAZIE AL SOSTEGNO IN VETRO TEMPERATO, ED HANNO UNA FORTE VALENZA SCENOGRAFICA OLTRE CHE PRATICA, CREANDO UN FILTRO TRA LA ZONA CUCINA E LA SALA DA PRANZO

SUSPENDED BASE CABINETS
THE BASE CABINETS WITH COOKTOP LOOK SUSPENDED, THANKS TO THE TEMPERED GLASS SUPPORT, AND PROVIDE BOTH A SCENOGRAPHIC AND A PRACTICAL FUNCTION, ACTING AS A FILTER BETWEEN THE KITCHEN AND THE DINING ROOM





16⁺ LUX

MELAMINICO GRIGIO NOTTE |
MELAMINICO ZINCO FINITURA OSSIDATA |
MELAMINICO LARICE VULCANO |
WORK TOP: GRIGIO ARDESIA POLARIS

*MIDNIGHT GREY MELAMINE |
OXIDISED FINISH ZINC MELAMINE |
VOLCANO LARCH MELAMINE |
WORK TOP: POLARIS SLATE GREY*







ELEMENTI A GIORNO 'AIR'

GLI ELEMENTI A GIORNO "AIR" SONO REALIZZATI CON PROFILO DA 20X20 MM E SCHIENALE IN ALLUMINIO CON RIPIANI IN VETRO BRONZO TEMPERATO 4 MM.

"AIR" OPEN SHELVING UNITS
"AIR" OPEN SHELVING UNITS FEATURE A 20X20MM PROFILE AND AN ALUMINIUM BACKREST WITH 4MM BRONZE TEMPERED GLASS SHELVES







+

PIANO SNACK SAGOMATO

MORBIDE CURVE DELINEANO IL PROFILO DEL PIANO SNACK, CHE TROVA IL SUO APPOGGIO SU UN ANGOLO DELLA PENISOLA SLANCIANDONE I VOLUMI.

SHAPED SNACK COUNTERTOP
SOFT CURVES DEFINE THE PROFILE OF THE SNACK COUNTERTOP, WHICH FINDS ITS SUPPORT IN A CORNER OF THE PENINSULA, LIGHTENING ITS VOLUMES.



17⁺ LUX

MELAMINICO CANSIGLIO SABBIA |
MELAMINICO VERDE MARINO |
WORK TOP: FENIX CACAO ORINOCO

*SAND CANSIGLIO MELAMINE |
SEA GREEN MELAMINE |
WORK TOP: ORINOCO CACAO FENIX*









CONTINUITÀ TRA LIVING E CUCINA

IL PROGRAMMA LIBRERIA NASCE DALLA ESIGENZA DI PERFETTA INTEGRAZIONE DELLA ZONA LIVING CON LA ZONA PRANZO E CUCINA. STESSA MODULARITÀ E FINITURE PER DUE ZONE CHE SEMPRE PIÙ SPESSO OCCUPANO LO STESSO SPAZIO ABITATIVO.

CONTINUITY BETWEEN LIVING ROOM AND KITCHEN THE BOOKCASE PROGRAM ORIGINATES FROM THE NEED OF A PERFECT INTEGRATION OF THE LIVING ROOM WITH THE DINING ROOM AND KITCHEN. SAME MODULARITY AND FINISHES FOR TWO AREAS WHICH MORE AND MORE FREQUENTLY SHARE THE SAME LIVING SPACE.



18⁺ LUX

MELAMINICO CANSIGLIO CHAMPAGNE |
LACCATO DESERT OPACO |
WORK TOP: LAMINATO MALTA VISIONE VINTAGE
FINITURA PLAMKY ABSI

CHAMPAGNE CANSIGLIO MELAMINE
MATT DESERT LACQUERED
WORK TOP: VINTAGE MINK MORTAR LAMINATED
ABSI PLAMKY FINISH









LUX 18

immagina plus



COLONNE NOOK

LE COLONNE ARMADIO "NOOK" CON ANTE A SCOMPARSA, CONSENTONO DI INSERIRE ALL'INTERNO FORNO, FRIGO, PIANO DI LAVORO E CASSETTI.

NOOK TALL CABINETS
THE "NOOK" CLOSET TALL CABINETS, WITH RETRACTABLE CABINET FRONTS, ALLOW TO INCORPORATE OVEN, REFRIGERATOR, COUNTERTOP AND DRAWERS.



19⁺ LUX

MELAMINICO OAK NEVE |
MELAMINICO MALTA LAVAGNA |
WORK TOP: LAMINATO OLD BLACK FINITURA URBAN

SNOW OAK MELAMINE |
SLATE GREY MORTAR MELAMINE |
WORK TOP: URBAN FINISH OLD BLACK LAMINATE









RICERCATEZZA DEI DETTAGLI

IL SISTEMA LIBRERIA, GRAZIE ALLA VASTA MODULARITÀ, RISOLVE OGNI NECESSITÀ ARREDATIVA ADATTANDOSI AD OGNI SPAZIO. LA LIBRERIA PUÒ ESSERE DOTATA DI ANTE E GLI SCHIENALI POSSONO ESSERE COLORATI COME LA STRUTTURA OPPURE A CONTRASTO.

REFINED DETAILS
THE BOOKCASE SYSTEM, THANKS TO THE WIDE MODULARITY, MEETS ALL FURNISHING NEEDS, ADAPTING TO EVERY SPACE. THE BOOKCASE IS AVAILABLE WITH CABINET FRONTS, AND THE BACKRESTS ARE AVAILABLE IN COLOURS MATCHED TO THE FRAMEWORK OR IN CONTRAST.







FINITURE⁺ &COLORI

MELAMINICI EFFETTO LEGNO, EFFETTO MATERICO, MALTA.
LACCATI, ACRILICI, GLAKS E VETRI

*FINISHES AND COLOURS
MORTAR, MATERIC EFFECT, WOOD EFFECT MELAMINE COMPONENTS
LACQUERED, ACRYLIC, GLAKS AND GLASSES*

EFFETTO LEGNO⁺ WOOD EFFECT

LARICE VULCANO
VOLCANO LARCH

LARICE BAGLIA
BAGLIA LARCH

NOCE
WALNUT

CANSIGLIO GRIGIO FUMO
CANSIGIO SMOKE GREY

MELAMINICO / MELAMINE

SP. 22 MM / TH. 22 MM

ANTE FINITURA OPACA CANSIGLIO VENATURA VERTICALE
DOORS WITH CANSIGLIO MATT FINISH WITH VERTICAL GRAIN

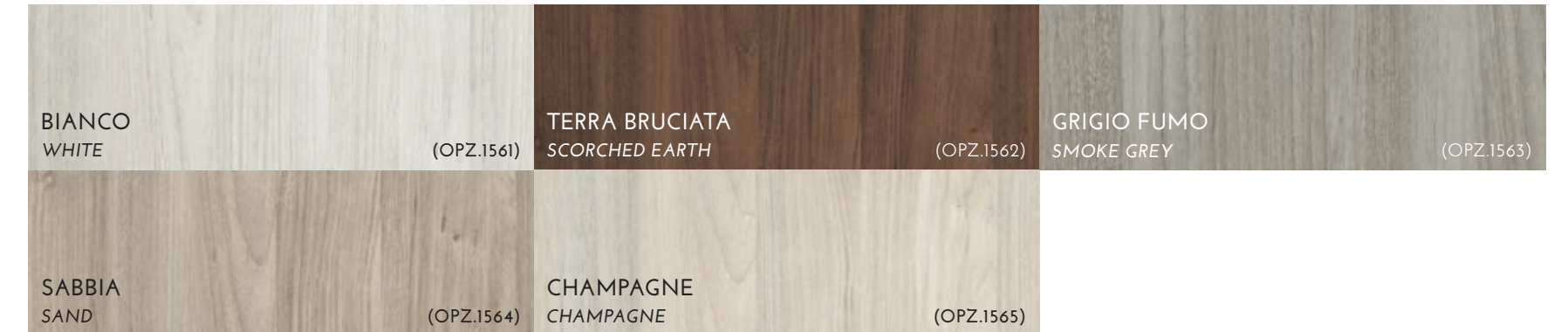

ANTE FINITURA OPACA PORO APERTO A REGISTRO VENATURA VERTICALE
DOORS WITH REGISTER OPEN-PORE FINISH WITH VERTICAL GRAIN

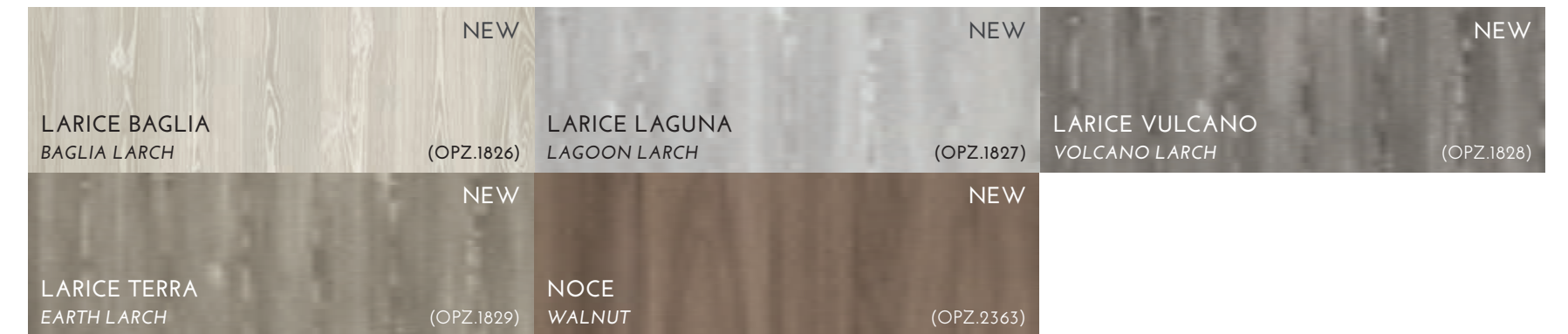

ANTE FINITURA OPACA SINCRO PORO EFFETTO LEGNO VENATURA VERTICALE
DOORS WITH SYNC PORE WOOD EFFECT MATT FINISH WITH VERTICAL GRAIN

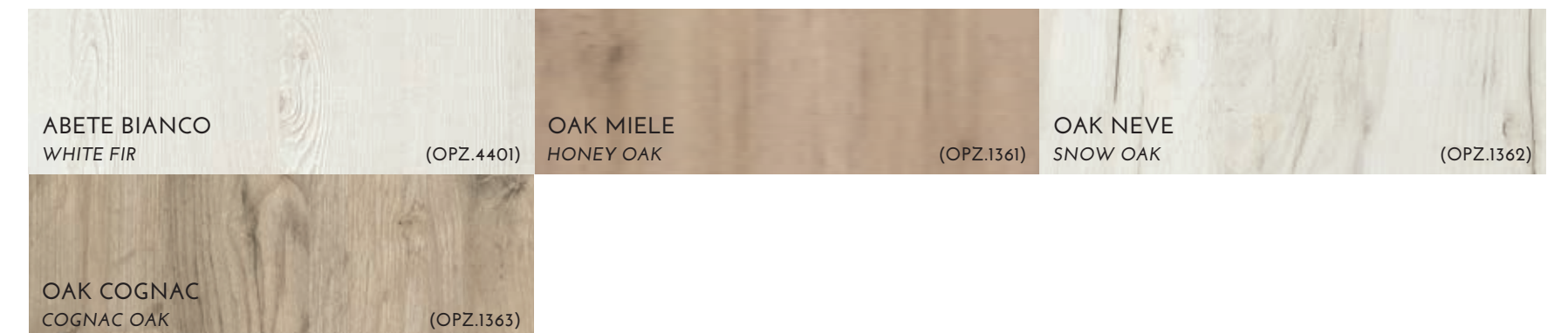

ANTE FINITURA OPACA SINCRO PORO EFFETTO LACCATO VENATURA ORIZZONTALE
DOORS WITH SYNC PORE LACQUERED EFFECT MATT FINISH WITH VERTICAL GRAIN



EFFETTO MATERICO⁺

MATERIC EFFECT



MELAMINICO / MELAMINE

SP. 22 MM / TH. 22 MM

ANTA FINITURA OPACA MATERICA
DOOR WITH TEXTURED MATT FINISH



ANTA FINITURA OPACA MARMORIZZATA
DOOR WITH MARBLED MATT FINISH

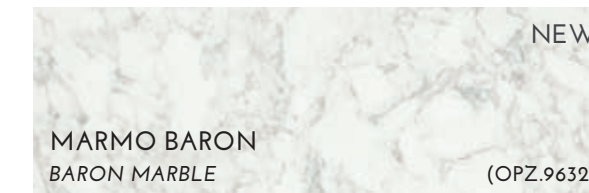

ANTE FINITURA OSSIDATA
DOORS WITH OXIDIZED FINISH

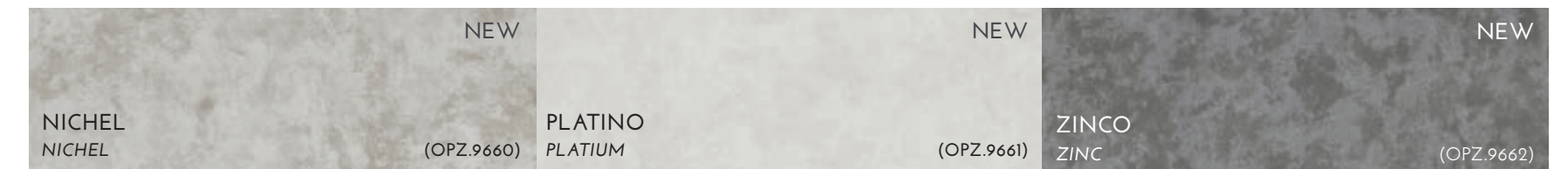

ANTE FINITURA SPAZZOLATA
DOORS WITH BRUSHED FINISH

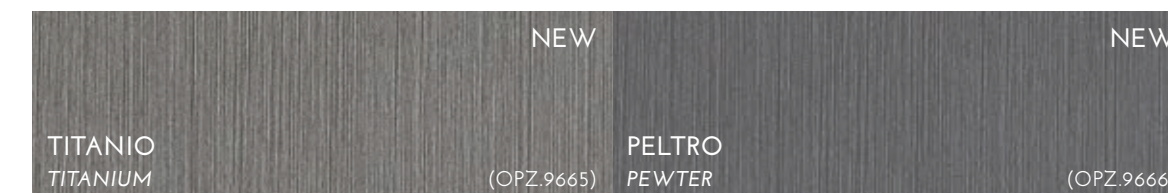

MALTA E + FINITURA MAT

MORTAR AND MAT FINISH

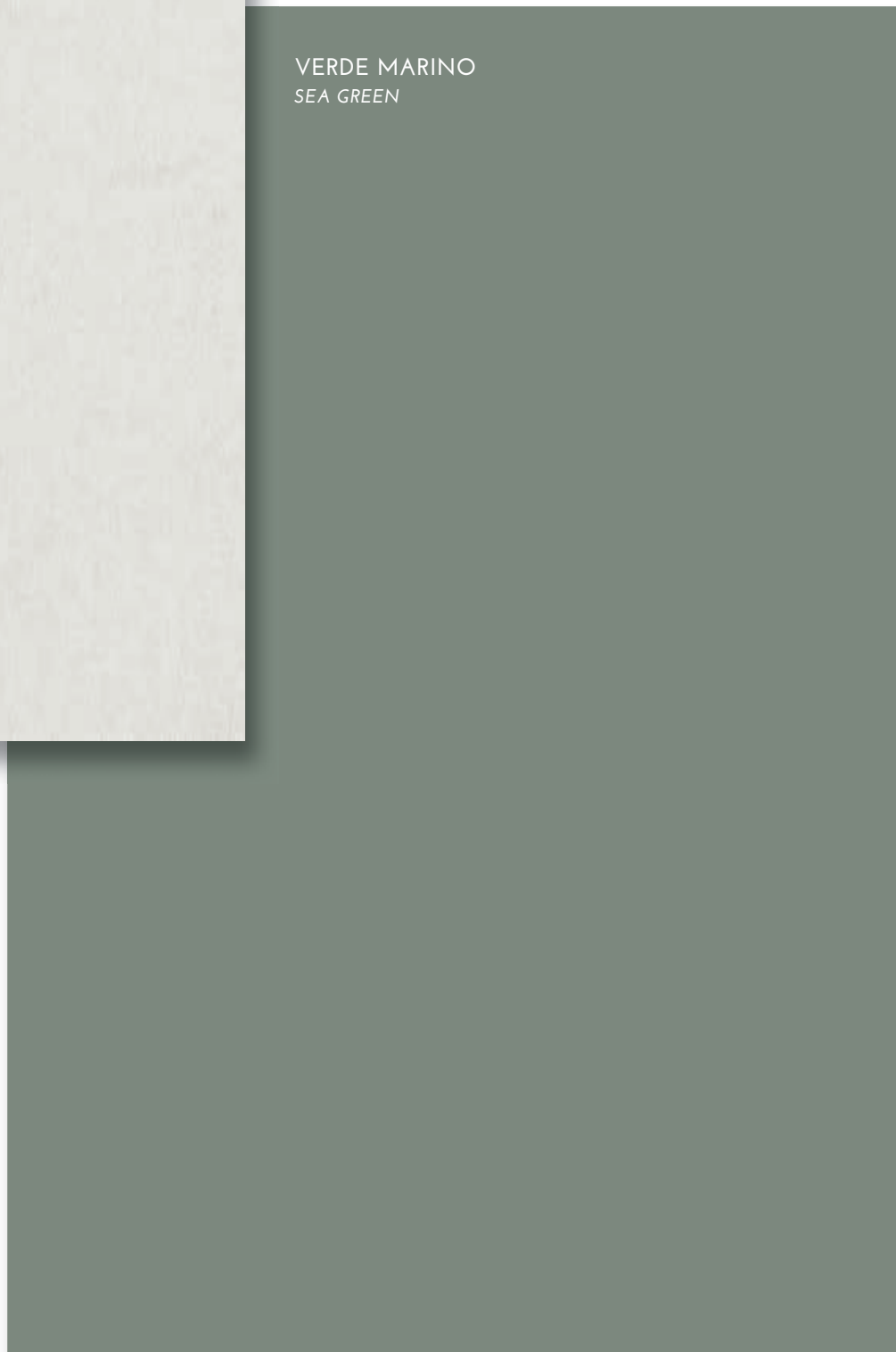

MELAMINICO / MELAMINE

SP. 22 MM / TH. 22 MM

ANTE FINITURA OPACA MALTA
DOORS WITH MORTAR MATT FINISH

BIANCO CRISTALLO CRISTAL WHITE (OPZ.7445)	GRIGIO NEBBIA FOG GREY (OPZ.9626)	CASTORO BEAVER (OPZ.8862)
LAVAGNA SLATE GREY (OPZ.9627)	JUTA JUTE (OPZ.8863)	

ANTE FINITURA MATT
DOORS WITH MATT FINISH

BIANCO ASSOLUTO ABSOLUTE WHITE (OPZ.7441)	BIANCO NEVE SNOW WHITE (OPZ.750)	GRIGIO SASSO PEBBLE GREY (OPZ.9650)	NEW
VERDE MARINO SEA GREEN (OPZ.8402)	GRIGIO MONSONE MONSOON GREY (OPZ.9651)	GRIGIO NOTTE MIDNIGHT GREY (OPZ.9652)	NEW
GRIGIO VELO VEIL GREY (OPZ.9653)	NEW		



ROSSO VINO
WINE RED



GRIGIO SINGAPORE
SINGAPORE GREY



GRIGIO ARENA
ARENA GREY



VERDE MALGA
ALPINE GREEN



TORTORA CHIARO
LIGHT DOVE GREY

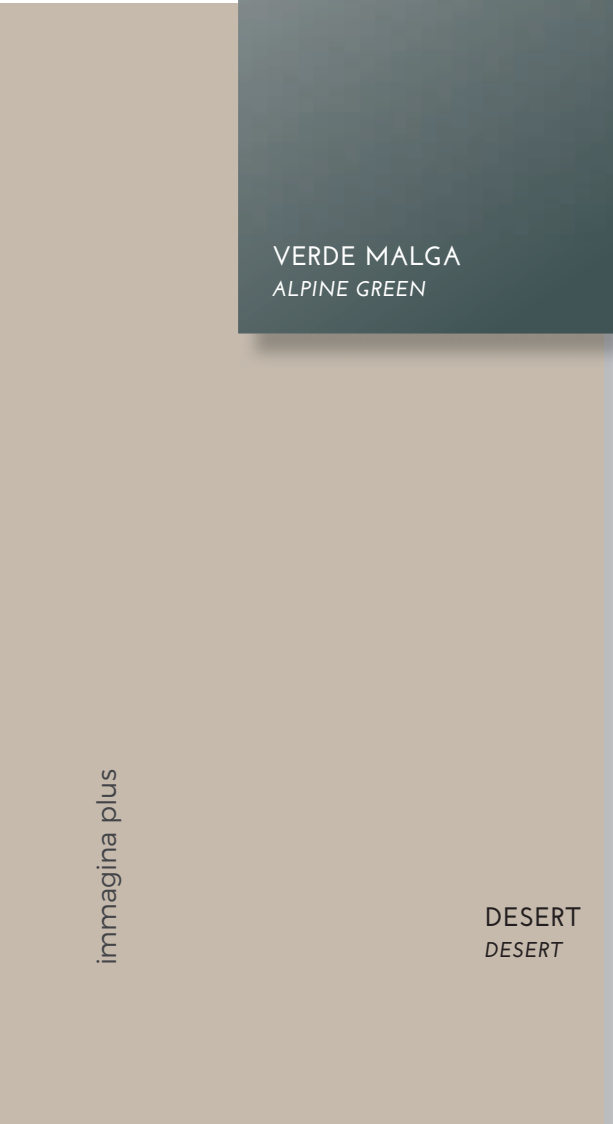

DESERT
DESERT

**LACCATO,
ACRILICO E
GLAKS**
+
**LACQUERED, ACRYLIC
AND GLAKS**

LACCATO / LACQUERED - NEW

SP. 22 MM / TH. 22 MM

ANTE FINITURA OPACA
DOORS WITH MATT FINISH

<p>BIANCO WHITE (OPZ.7405)</p>	<p>ANTRACITE ANTHRACITE (OPZ.9558)</p>	<p>GRIGIO ARENA ARENA GREY (OPZ.9521)</p>
<p>ROSSO VINO WINE RED (OPZ.8163)</p>	<p>BIANCO NEVE SNOW WHITE (OPZ.7407)</p>	<p>VERDE MALGA ALPINE GREEN (OPZ.8477)</p>
<p>DESERT DESERT (OPZ.8941)</p>	<p>POLVERE DUST (OPZ.9529)</p>	<p>ARDESIA SLATE GREY (OPZ.9525)</p>

ANTE FINITURA LUCIDA
DOORS WITH GLOSSY FINISH

<p>BIANCO WHITE (OPZ.7406)</p>	<p>ANTRACITE ANTHRACITE (OPZ.9559)</p>	<p>GRIGIO ARENA ARENA GREY (OPZ.9522)</p>
<p>DESERT DESERT (OPZ.8942)</p>	<p>POLVERE DUST (OPZ.9530)</p>	<p>ARDESIA SLATE GREY (OPZ.9526)</p>

ACRILICO - ACRYLIC

SP. 22 MM / TH. 22 MM

ANTE ACRILICO OPACO / LUCIDO
MATT/GLOSSY ACRYLIC DOORS

BIANCO ASSOLUTO ABSOLUTE WHITE (OPZ.7495)	BIANCO CALDO WARM WHITE (OPZ.7497)	TORTORA CHIARO LIGHT DOVE GREY (OPZ.896A)	NEW
(OPZ.7496)	(OPZ.7498)	(OPZ.895A)	
VISONE MINK (OPZ.946A)	ROSSO VENEZIANO VENETIAN RED (OPZ.8147)	GRIGIO REALE ROYAL GREY (OPZ.9565)	
(OPZ.947A)	(OPZ.8148)	(OPZ.9566)	
GRIGIO SINGAPORE SINGAPORE GREY (OPZ.9575)	VERDE FELCE FERN GREEN (OPZ.8457)	ARGILLA CLAY (OPZ.9573)	NEW
(OPZ.9576)	(OPZ.8458)	(OPZ.9574)	
GRIGIO PIOMBO LEAD GREY (OPZ.9569)	GRIGIO ALASKA ALASKA GREY (OPZ.9581)	BLU FUMO SMOKE BLUE (OPZ.8353)	
(OPZ.9570)	(OPZ.9582)	(OPZ.8354)	
GRIGIO OMBRA SHADOW GREY (OPZ.9585)			
(OPZ.9586)			

GLAKS

SP. 22 MM / TH. 22 MM

ANTE IN ACRILICO EFFETTO VETRO, COLORI OPACHI E LUCIDI
GLASS EFFECT ACRYLIC DOORS, MATT AND GLOSSY COLOURS

BIANCO ASSOLUTO ABSOLUTE WHITE (OPZ.7491)	BIANCO CALDO WARM WHITE (OPZ.7493)	TORTORA CHIARO LIGHT DOVE GREY (OPZ.896G)	NEW
(OPZ.7492)	(OPZ.7494)	(OPZ.895G)	
VISONE MINK (OPZ.946G)	FANGO MUD (OPZ.8883)	GRIGIO REALE ROYAL GREY (OPZ.9563)	
(OPZ.947G)	(OPZ.8884)	(OPZ.9564)	
GRIGIO SINGAPORE SINGAPORE GREY (OPZ.9577)	ARGILLA CLAY (OPZ.9571)	GRIGIO PIOMBO LEAD GREY (OPZ.9567)	
(OPZ.9578)	(OPZ.9572)	(OPZ.9568)	
GRIGIO ALASKA ALASKA GREY (OPZ.9583)	BLU FUMO SMOKE BLUE (OPZ.8355)	GRIGIO OMBRA SHADOW GREY (OPZ.9587)	NEW
(OPZ.9584)	(OPZ.8356)	(OPZ.9588)	



TELAIO ALLUMINIO - ALUMINIUM FRAME

DI SERIE: TELAI0 ALLUMINIO TITANIO SP.22 MM VETRO SATINATO, BRONZO O FUMÈ
STANDARD: 22 MM TH. TITANIUM ALUMINIUM FRAME SATIN, BRONZE OR FUMÈ GLASS



TELAIO TITANIO CON
VETRO SATINATO
TITANIUM FRAME WITH
SATIN GLASS
(OPZ.TISAT)



TELAIO TITANIO CON
VETRO BRONZO
TITANIUM FRAME WITH
BRONZE GLASS
(OPZ.TIBRZ)



TELAIO TITANIO CON
VETRO FUMÈ
TITANIUM FRAME WITH
FUMÈ GLASS
(OPT.TIFUM)

A RICHIESTA : TELAI0 ALLUMINIO VERNICIATO URBAN SP.22 MM VETRO SATINATO, BRONZO O FUMÈ
ON REQUEST: 22 MM TH. URBAN PAINTED ALUMINIUM FRAME SATIN, BRONZE OR FUMÈ GLASS



TELAIO URBAN CON
VETRO SATINATO
URBAN FRAME WITH
SATIN GLASS
(OPZ.GISAT)



TELAIO URBAN CON
VETRO BRONZO
URBAN FRAME WITH
BRONZE GLASS
(OPZ.GIBRZ)



TELAIO URBAN CON
VETRO FUMÈ
URBAN FRAME WITH
FUMÈ GLASS
(OPZ.GIFUM)

A RICHIESTA : TELAI0 ALLUMINIO VERNICIATO SILVER DARK SP.22 MM VETRO SATINATO, BRONZO O FUMÈ
ON REQUEST: 22 MM TH. SILVER DARK PAINTED ALUMINIUM FRAME SATIN, BRONZE OR FUMÈ GLASS



TELAIO SILVER DARK
CON VETRO SATINATO
SILVER DARK FRAME WITH
SATIN GLASS
(OPZ.PISAT)



TELAIO SILVER DARK
CON VETRO BRONZO
SILVER DARK FRAME WITH
BRONZE GLASS
(OPZ.PIBRZ)



TELAIO SILVER DARK
CON VETRO FUMÈ
SILVER DARK FRAME WITH
FUMÈ GLASS
(OPT.PIFUM)

VETRO +
GLASS

ZOCCOLI, GOLE E MANIGLIA BLEND PLINTH, FINGER-RAIL AND BLEND HANDLE

ZOCCOLI IN ALLUMINIO H 13 ALLUMINIUM PLINTHS H 13

TITANIO OSSIDATO TITANIUM OXIDIZED (OPZ.414)	BRILL BRILL (OPZ.412)	URBAN OSSIDATO URBAN OXIDIZED (OPZ.NU)
--	-----------------------------	--

ZOCCOLI IN PVC H 13 PVC PLINTHS H 13

BIANCO WHITE (OPZ.001)	ACCIAIO STEEL (OPZ.407)	ALLUMINIO SATINATO SATIN ALUMINIUM (OPZ.405)
------------------------------	-------------------------------	--

ZOCCOLI IN ALLUMINIO H 13 VERNICIATI A POLVERE FINITURA OPACA ALUMINIUM PLINTHS H 13 POWDER COATED MATT FINISH

BIANCO ASSOLUTO ABSOLUTE WHITE (OPZ.7405)	BIANCO CALDO WARM WHITE (OPZ.7401)	CONCHIGLIA SHELL (OPZ.7403)	NEW
GIALLO MAIS ABSOLUTE WHITE (OPZ.8251)	GIALLO AMBRA AMBER YELLOW (OPZ.8225)	GRIGIO TRAFFICO TRAFFIC GREY (OPZ.9511)	NEW
GHISA CAST IRON	CASTORO BEAVER (OPZ.8907)	FUMO SMOKE (OPZ.9531)	NEW
ROSA QUARZO QUARZ PINK (OPZ.8171)	ROSSO CORALLO CORAL RED (OPZ.8131)	ROSSO TOSCANO TUSCAN RED (OPZ.8157)	
SALVIA SAGE (OPZ.8443)	ACQUAMARINA ACQUAMARINE (OPZ.8323)	CENERE ASH (OPZ.9547)	
GRIGIO PIOMBO MINK (OPZ.9537)	GRIGIO BROMO BROMINE GREY (OPZ.9533)	SILVER DARK DARK SILVER (OPZ.9507)	NEW
ARGILLA CLAY (OPZ.9503)	NERO BLACK (OPZ.7892)		

FINITURE PROFILI E GOLE SPAZZOLATI FINGER RAILS AND PROFILES BRUSHED FINISHES

TITANIO OSSIDATO TITANIUM OXIDIZED (OPZ.414)	BRILL BRILL (OPZ.412)	URBAN OSSIDATO URBAN OXIDIZED (OPZ.NU)
--	-----------------------------	--

FINITURE PROFILI E GOLE VERNICIATI A POLVERE OPACHI MATT FINGER RAILS AND PROFILES POWDER COATED FINISHES

BIANCO ASSOLUTO ABSOLUTE WHITE (OPZ.7405)	BIANCO CALDO WARM WHITE (OPZ.7401)	CONCHIGLIA SHELL (OPZ.7403)	NEW
GIALLO MAIS ABSOLUTE WHITE (OPZ.8251)	GIALLO AMBRA AMBER YELLOW (OPZ.8225)	GRIGIO TRAFFICO TRAFFIC GREY (OPZ.9511)	NEW
GHISA CAST IRON	CASTORO BEAVER (OPZ.8907)	FUMO SMOKE (OPZ.9531)	NEW
ROSA QUARZO QUARZ PINK (OPZ.8171)	ROSSO CORALLO CORAL RED (OPZ.8131)	ROSSO TOSCANO TUSCAN RED (OPZ.8157)	
SALVIA SAGE (OPZ.8443)	ACQUAMARINA ACQUAMARINE (OPZ.8323)	CENERE ASH (OPZ.9547)	
GRIGIO PIOMBO MINK (OPZ.9537)	GRIGIO BROMO BROMINE GREY (OPZ.9533)	SILVER DARK DARK SILVER (OPZ.9507)	NEW
ARGILLA CLAY (OPZ.9503)	NERO BLACK (OPZ.7892)	BISTRO BISTRO (OPZ.9535)	

COLORI INTERNI OPACHI MANIGLIA "BLEND" INTERNAL MATT COLOURS FOR "BLEND" HANDLE

BIANCO ASSOLUTO ABSOLUTE WHITE (OPZ.7405)	BIANCO CALDO WARM WHITE (OPZ.7401)	FUMO SMOKE (OPZ.9531)
ROSA QUARZO QUARZ PINK (OPZ.8171)	ROSSO CORALLO CORAL RED (OPZ.8131)	ROSSO TOSCANO TUSCAN RED (OPZ.8157)
GIALLO AMBRA AMBER YELLOW (OPZ.8225)	SALVIA SAGE (OPZ.8443)	ACQUAMARINA ACQUAMARINE (OPZ.8323)
TITANIO TITANIUM (OPZ.414)	NERO BLACK (OPZ.7892)	

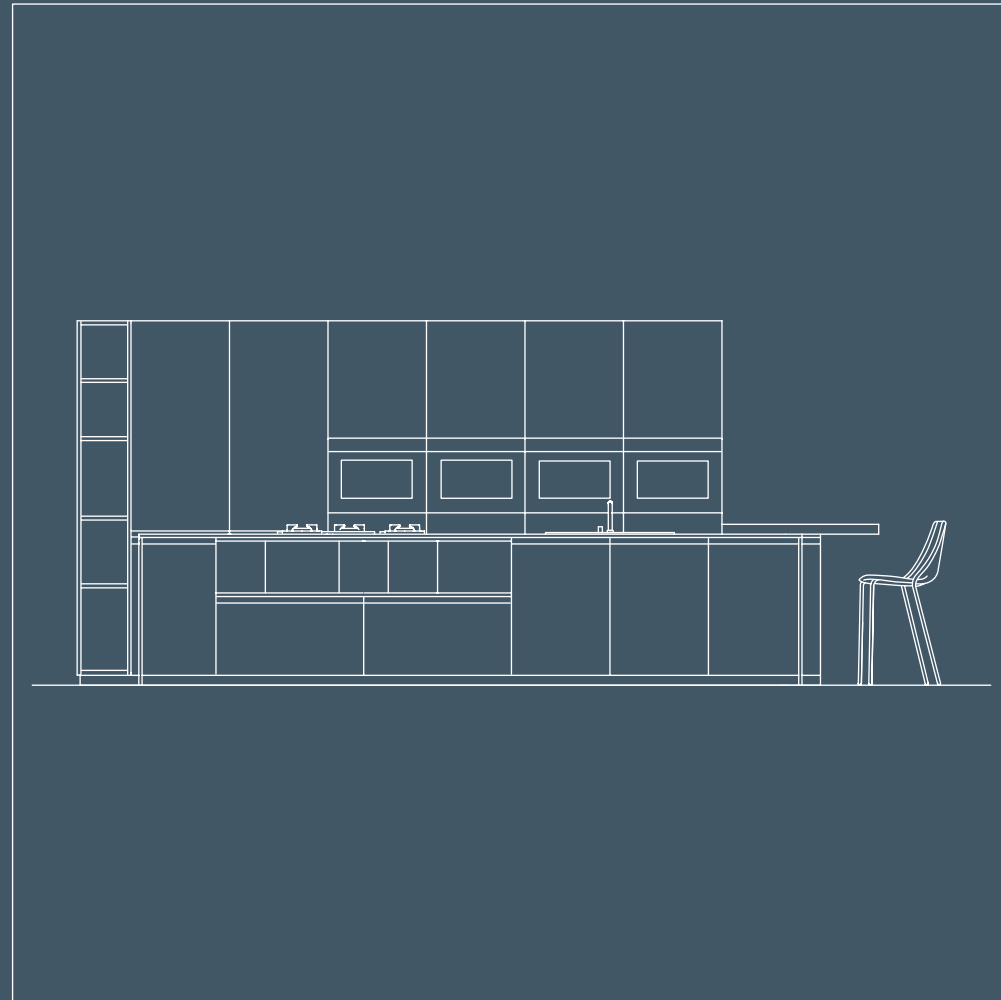

INFORMAZIONI⁺ TECNICHE

DETTAGLIO DEI MATERIALI, FINITURE, COMPLEMENTI E DISEGNI
TECNICI DELLE COMPOSIZIONI DELLA NUOVA COLLEZIONE
IMMAGINA PLUS 2018

*TECHNICAL INFORMATION
DETAIL OF MATERIALS, FINISHES, FURNISHING ACCESSORIES AND
TECHNICAL DRAWINGS OF COMPOSITIONS OF THE NEW COLLECTION
IMMAGINA PLUS 2018*



TIPOLOGIE DI APERTURE

OPENING SYSTEMS



BRIDGE

ANTA QUADRATA CON MANIGLIA:
SQUARE DOOR WITH HANDLE

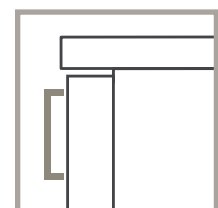

FRONTALE
ANTA CON MANIGLIA FRONTALE
FRONTAL / DOOR WITH FRONT HANDLE

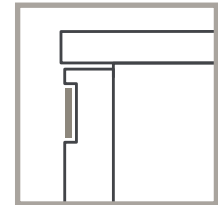

BLEND AD INCASSO
ANTA CON MANIGLIA INCASSATA
RECESSED BLEND / DOOR WITH RECESSED HANDLE



NECK

ANTA SENZA PROFILO PER APERTURA CON GOLA
DOOR WITHOUT PROFILE FOR FINGER RAIL OPENING

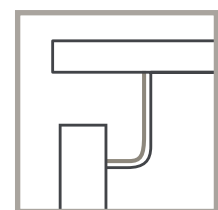

GOLA TIPO "ELLE"



LUX

APERTURE CON GOLA
OPENINGS WITH FINGER RAIL

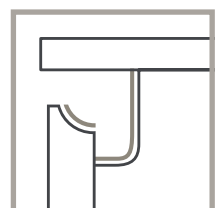

ANTA CON PROFILO CURVO
DOOR WITH CURVED PROFILE

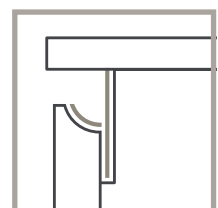

ANTA CON PROFILO AD "ELLE"
DOOR WITH "L-SHAPED" PROFILE

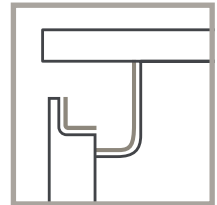

ANTA CON PROFILO INCLINATO
DOOR WITH INCLINED PROFILE

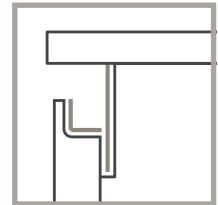

GOLA PIATTA

GOLA TIPO "ELLE"



HEAD

ANTA CON MANIGLIA APPLICATA IN TESTA
DOOR WITH TOP-MOUNTED HANDLE

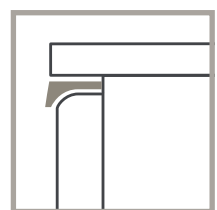

.BRIDGE/01

MELAMINICO MARMO BARON | MELAMINICO NOCE



LIBRERIA
STRUTTURA MELAMINICO VERDE MARINO
ANTE MELAMINICO VERDE MARINO E
MELAMINICO MARMO BARON

BOOKCASE
SEA GREEN MELAMINE FRAMEWORK
SEA GREEN MELAMINE CABINET FRONTS AND
BARON MARBLE MELAMINE

ANTE BASI
MELAMINICO MARMO BARON
MELAMINICO NOCE

BASE CABINETS FRONTS
BARON MARBLE MELAMINE
WALNUT MELAMINE



(OPZ.9632)



(OPZ.2363)

ANTE COLONNE
MELAMINICO NOCE

TALL CABINETS FRONTS
WALNUT MELAMINE

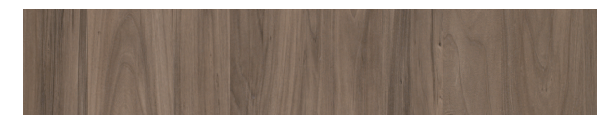

(OPZ.2363)

MANIGLIA
MANIGLIA M42 E M42V FINITURA NICHEL SATINATO
HANDLE
M42 HANDLE AND M42V SATIN NICKEL FINISH

KUSET

TAVOLO
STRUTTURA METALLO VERNICIATO FUMO (OPZ. FU)
PIANO NOCE

TABLE
SMOKE VARNISHED METAL FRAMEWORK (OPT. FU)
WALNUT COUNTERTOP



WORK TOP
ACCIAIO INOX FINITURA VINTAGE

WORK TOP
STAINLESS STEEL VINTAGE FINISH



ZOCCOLO
TITANIO

PLINTH
TITANIUM



(OPZ.414)

MASTER

SGABELLO
STRUTTURA IN METALLO VERNICIATO BIANCO
(COD. 084MTGBC)
RIVESTIMENTO CUIO VERDE SALVIA (OPZ. U69)

STOOL
WHITE VARNISHED METAL FRAMEWORK
(CODE 084MTGBC)
MINT-GREEN LEATHER COVER (OPT. U69)

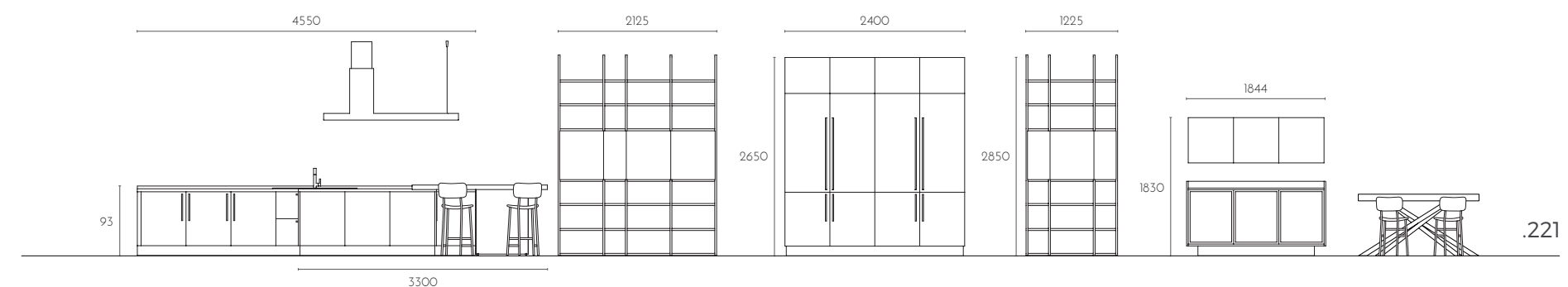

.NECK/14

MELAMINICO CANSIGLIO GRIGIO FUMO | MELAMINICO PLATINO FINITURA OSSIDATA
| MELAMINICO MALTA LAVAGNA



GOLA/ZOCCOLO
NERO
FINGER RAIL/PLINTH
BLACK



(OPZ.7892)

WORK TOP
LAMINATO H4 BIANCO FINITURA VELVET ABSI

WORK TOP
ABSI VELVET FINISH WHITE H4 LAMINATE



(OPZ.800)

ANTE BASI
MELAMINICO CANSIGLIO GRIGIO FUMO

BASE CABINETS FRONTS
SMOKE GREY CANSIGLIO MELAMINE



(OPZ.1563)

ELEMENTI A GIORNO LIVING
NERO

LIVING OPEN SHELIVING UNITS
BLACK



ANTE COLONNE/PENSILI
MELAMINICO PLATINO FINITURA OSSIDATA

UPPER/TALL CABINETS FRONTS
OXIDISED FINISH PLATINUM MELAMINE

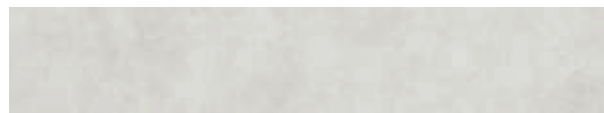

(OPZ.9661)

MINOX

TAVOLO
STRUTTURA METALLO VERNICIATO NERO (OPZ. NE)
PIANO LAMINATO MALTA OLD BLACK (OPZ. LM14)

TABLE
BLACK VARNISHED METAL FRAMEWORK (OPZ. NE)
OLD BLACK MORTAR LAMINATE COUNTERTOP (OPZ. LM14)



ANTE PENSILI
MELAMINICO MALTA LAVAGNA

UPPER CABINETS FRONTS
SLATE GREY MORTAR MELAMINE



(OPZ.9627)

QUILT

SEDIA

STRUTTURA PROPILENE SENAPE (OPZ. P973)

CHAIR

MUSTARD PROPYLENE FRAMEWORK (OPT. P973)



.LUX/15

MELAMINICO PELTRO | MELAMINICO LARICE LAGUNA | MELAMINICO VERDE MARINO



GOLA/ZOCCOLO
FUMO

FINGER RAIL/PLINTH
SMOKE



(OPZ.9531)

WORK TOP
UNICOLOR GRIGIO MONSONE

WORK TOP
MONSOON GREY UNICOLOR



(OPZ.1038)

ANTE BASI
MELAMINICO PELTRO

BASE CABINETS FRONTS
PEWTER MELAMINE



(OPZ.9666)

ELEMENTI MODULAR
BRUNITO (OPZ. B)
SCHIENALI FENIX FUMO (OPZ. 0718)

MODULAR ELEMENTS
BURRISHED (OPT. B)
BACK PANEL SMOKE FENIX (OPT. 0718)

OLA

SGABELLO/SEDIA
STRUTTURA FERRO INVECCHIATO
(COD. SGABELLO 084OLGJC / SEDIA 084OLDJC)
SEDUTA ECOPELLE VERDE BOSCO (OPZ. 7S8)

STOOL/CHAIR
AGED IRON FRAMEWORK
(STOOL CODE 084OLGJC / CHAIR 084OLDJC)
FOREST GREEN PLEATHER SEAT (OPT. 7S8)



ANTE COLONNE
MELAMINICO LARICE LAGUNA

TALL CABINETS FRONTS
LAGOON LARCH MELAMINE



(OPZ.1827)

POK OVALY

TAVOLO
STRUTTURA FERRO GREZZO (OPZ. FG)
PIANO IMPIALLACCIATO ROVERE POLVERE
(OPZ. 5402)

TABLE
IRON ORE FRAMEWORK (OPT. FG)
DUST GREY OAK VENEERED COUNTERTOP (OPT. 5402)



ANTE PENSILI
MELAMINICO VERDE MARINO

UPPER CABINETS FRONTS
SEA GREEN MELAMINE



(OPZ.8402)

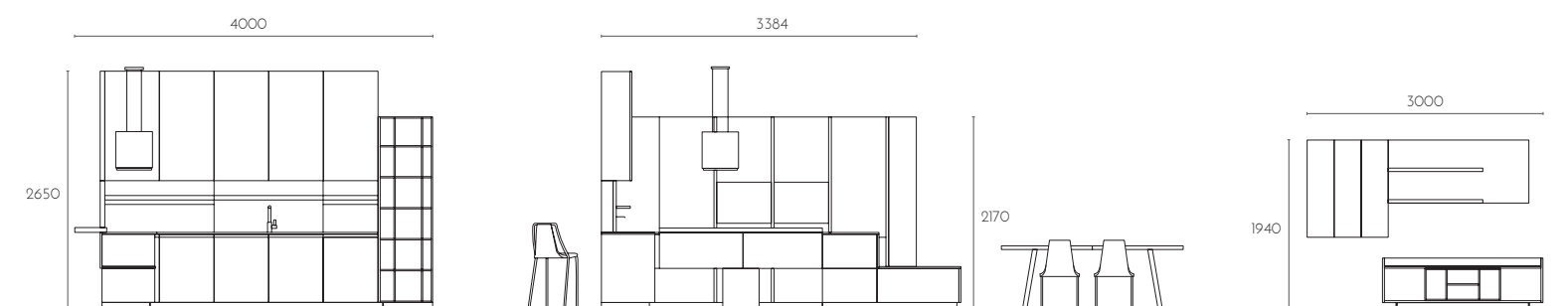

.LUX/16

MELAMINICO GRIGIO NOTTE | MELAMINICO ZINCO FINITURA OSSIDATA | MELAMINICO LARICE VULCANO



GOLA/ZOCCOLO
SILVER DARK
FINGER RAIL/PLINTH
DARK SILVER



(OPZ.9507)

WORK TOP
GRIGIO ARDESIA POLARIS
WORK TOP
POLARIS SLATE GREY



(OPZ.2909)

ANTE BASI
MELAMINICO GRIGIO NOTTE
BASE CABINETS FRONTS
MIDNIGHT GREY MELAMINE



(OPZ.9652)

ANTE PENSILI - LIVING
LACCATO ARDESIA
UPPER CABINETS FRONTS - LIVING
LACQUERED SLATE GREY



(OPZ.9525)

PIANO SNACK
LAMINATO LARICE VULCANO
SNACK COUNTER
VOLCANO LARCH LAMINATE



(OPZ.1828)

ANTE COLONNE
MELAMINICO ZINCO FINITURA OSSIDATA
TALL CABINETS FRONTS
OXIDISED FINISH ZINC MELAMINE



(OPZ.9662)

ANTE PENSILI
MELAMINICO LARICE VULCANO
UPPER CABINETS FRONTS
VOLCANO LARCH MELAMINE



(OPZ.1828)

SLIM
SGABELLO
STRUTTURA METALLO VERNICIATO NERO
(COD. 084SMGN)
SEDUTA CUOIO GRIGIO KENYA (OPZ. U18)
STOOL
BLACK VARNISHED METAL FRAMEWORK
(CODE 084SMGN)
KENYA GREY LEATHER SEAT (OPT. U18)

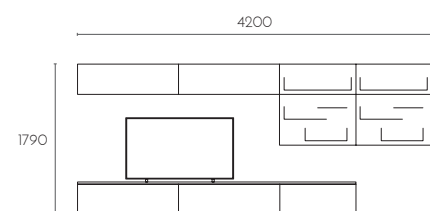
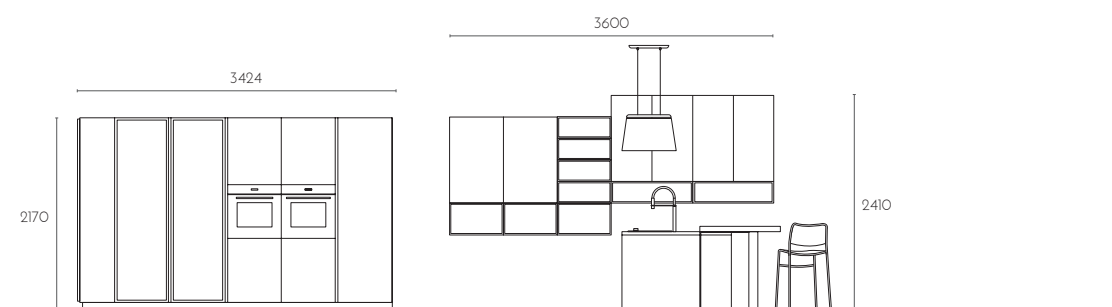
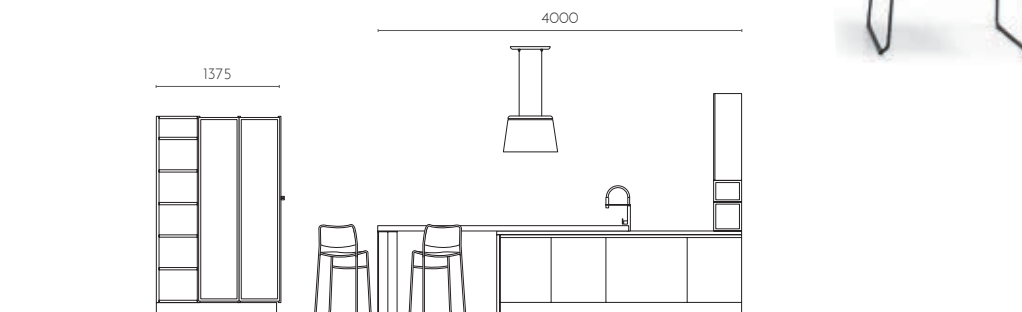

.LUX/17

MELAMINICO CANSIGLIO SABBIA | MELAMINICO VERDE MARINO



GOLA/ZOCCOLO
GHISA
FINGER RAIL/PLINTH
CAST IRON



(OPZ.9509)

WORK TOP
FENIX CACAO ORINOCO
WORK TOP
ORINOCO CACAO FENIX

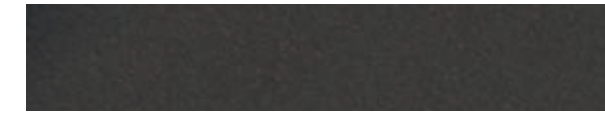

(OPZ.0749)

ANTE BASI
MELAMINICO CANSIGLIO SABBIA
BASE CABINETS FRONTS
SAND CANSIGLIO MELAMINE



(OPZ.1564)

LIBRERIA
STRUTTURA/SCHIENALI MELAMINICO LAVAGNA
ANTE MELAMINICO NICHEL FINITURA OSSIDATA

BOOKCASE
SLATE GREY MELAMINE FRAMEWORK/BACKRESTS
OXIDISED FINISH NICHEL MELAMINE CABINET
FRONTS



(OPZ.9620)



(OPZ.9660)

ANTE COLONNE/PENSILI
MELAMINICO VERDE MARINO
TALL/UPPER CABINETS FRONTS
SEA GREEN MELAMINE



(OPZ.8402)

BIRG
SEDIA
STRUTTURA METALLO VERNICIATO NERO OPACO
(COD. 084BIDNP)
SEDUTA VERDE (OPZ. ED)
CHAIR
MATT BLACK VARNISHED METAL FRAMEWORK
(CODE 084BIDNP)
GREEN SEAT (OPT. ED)

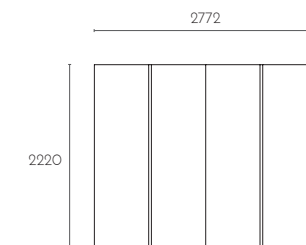
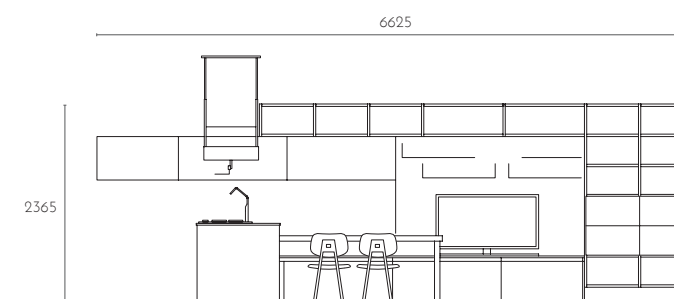

.LUX/18

MELAMINICO CANSIGLIO CHAMPAGNE | LACCATO DESERT OPACO



GOLA/ZOCCOLO
TITANIO OSSIDATO
FINGER RAIL/PLINTH
OXIDISED TITANIUM



(OPZ.414)

WORK TOP
LAMINATO MALTA VISONE VINTAGE
FINITURA PLAMKY ABSI

WORK TOP
VINTAGE MINK MORTAR LAMINATE
PLAMKY ABSI FINISH



(OPZ.5568)

ANTE BASI/PENSILI
MELAMINICO CANSIGLIO CHAMPAGNE
BASE/UPPER CABINETS FRONTS
CHAMPAGNE CANSIGLIO MELAMINE



(OPZ.1565)

LIBRERIA
STRUTTURA VISONE
SCHIENALI CANSIGLIO CHAMPAGNE

BOOKCASE
MINK FRAMEWORK
CHAMPAGNE CANSIGLIO BACKRESTS



(OPZ.948M)

ANTE COLONNE/PENSILI
LACCATO DESERT OPACO
TALL/UPPER CABINETS FRONTS
MATT DESERT LACQUERED



(OPZ.8941)

MENSOLE
IN LAMIERA VERNICIATA ROSSO TOSCANO
CON SCHIENALE MELAMINICO CANSIGLIO
CHAMPAGNE

SHELVES
TUSCAN RED PAINTED STEEL
WITH CHAMPAGNE CANSIGLIO BACK PANEL



(OPZ.8157)



(OPZ.1565)

PENISOLA
LAMINATO CANSIGLIO CHAMPAGNE
PENINSULA
LAMINATE CHAMPAGNE CANSIGLIO



(OPZ.1565)

GAMY
SEDIA
STRUTTURA ROSSO (OPZ. P946)
CHAIR
RED FRAMEWORK (OPT. P946)



.LUX/19

MELAMINICO OAK NEVE | MELAMINICO MALTA LAVAGNA



GOLA/ZOCCOLO
NERO
FINGER RAIL/PLINTH
BLACK



(OPZ.7892)

ANTE BASI/COLONNE
MELAMINICO OAK NEVE
MELAMINICO MALTA LAVAGNA

BASE/TALL CABINETS FRONTS
SNOW OAK MELAMINE
SLATE GREY MORTAR MELAMINE



(OPZ.1362)



(OPZ.9627)

LIBRERIA
STRUTTURA MELAMINICO LAVAGNA
ANTE MELAMINICO OAK BIANCO NEVE
E MALTA LAVAGNA
SCHIENALI LACCATO GIALLO AMBRA OPACO

BOOKCASE
SLATE GREY MELAMINE FRAMEWORK
SNOW WHITE OAK MELAMINE CABINET FRONTS
AND SLATE GREY MORTAR
MATT AMBER YELLOW LACQUERED BACKRESTS



(OPZ.9620)



(OPZ.1362)



(OPZ.3275)

WORK TOP
LAMINATO OLD BLACK FINITURA URBAN

WORK TOP
URBAN FINISH OLD BLACK LAMINATE



(OPZ.LM14)

SLIM
SGABELLO
STRUTTURA METALLO VERNICIATO NERO
(O84SMGN)
SEDUTA CUIO GIALLO OCRA (OPZ. U22)
STOOL
BLACK VARNISHED METAL FRAMEWORK (O84SMGN)
YELLOW OCHRE LEATHER SEAT (OPT. U22)



immagina plus

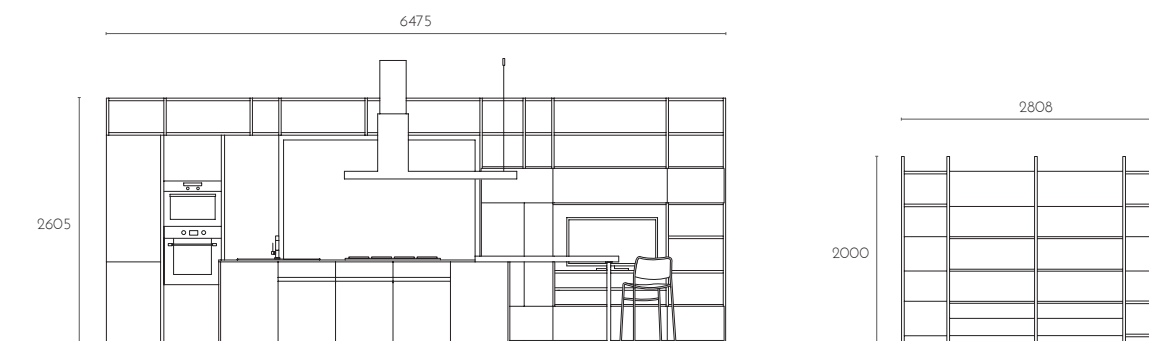

PROGETTO E COORDINAMENTO
UFFICIO R&S
UFFICIO MKT
'LUBE SERVICE & ENGINEERING S.R.L.'
STUDIO FERRIANI

GRAFICA
STUDIO FERRIANI

DIGITAL PHOTOGRAPHY
STUDIO FERRIANI

SELEZIONI
GRAFICHE ANTIGA

STAMPA
GRAFICHE ANTIGA



stampato
con il sole



PRINTED
NOVEMBRE 2018

LUBE INDUSTRIES SRL
VIA DELL'INDUSTRIA, 4
62010 TREIA (MC) ITALIA
TEL. CENTRALINO 0733 8401 (R.A.)
FAX. 0733 840222 - 0733 840333
INFO@CUCINELUBE.IT
WWW.CUCINELUBE.IT

LUBE INDUSTRIES SRL SI RISERVA LA FACOLTA' DI APPORTARE IN OGNI MOMENTO E
SENZA PREAVVISO QUALSIASI MODIFICA TECNICA E CROMATICA RITENUTE UTILI AL
MIGLIORAMENTO DEI PROPRI PRODOTTI.
I CAMPIONI E I COLORI RIPRODOTTI SONO PURAMENTE INDICATIVI.
LA RAPPRESENTAZIONE IN STAMPA PUO' ALTERARE LE TONALITA' DEI COLORI.

LUBE INDUSTRIES SRL RESERVES THE RIGHT TO MAKE AT ANY TIME AND WITHOUT PRIOR NOTICE ANY
TECHNICAL AND COLOUR MODIFICATION DEEMED USEFUL FOR THE IMPROVEMENT OF ITS PRODUCTS.
THE SHOWN SAMPLES AND COLOURS ARE PURELY INDICATIVE.
PRINTED REPRESENTATION MAY ALTER THE ACTUAL COLOUR TONES.